

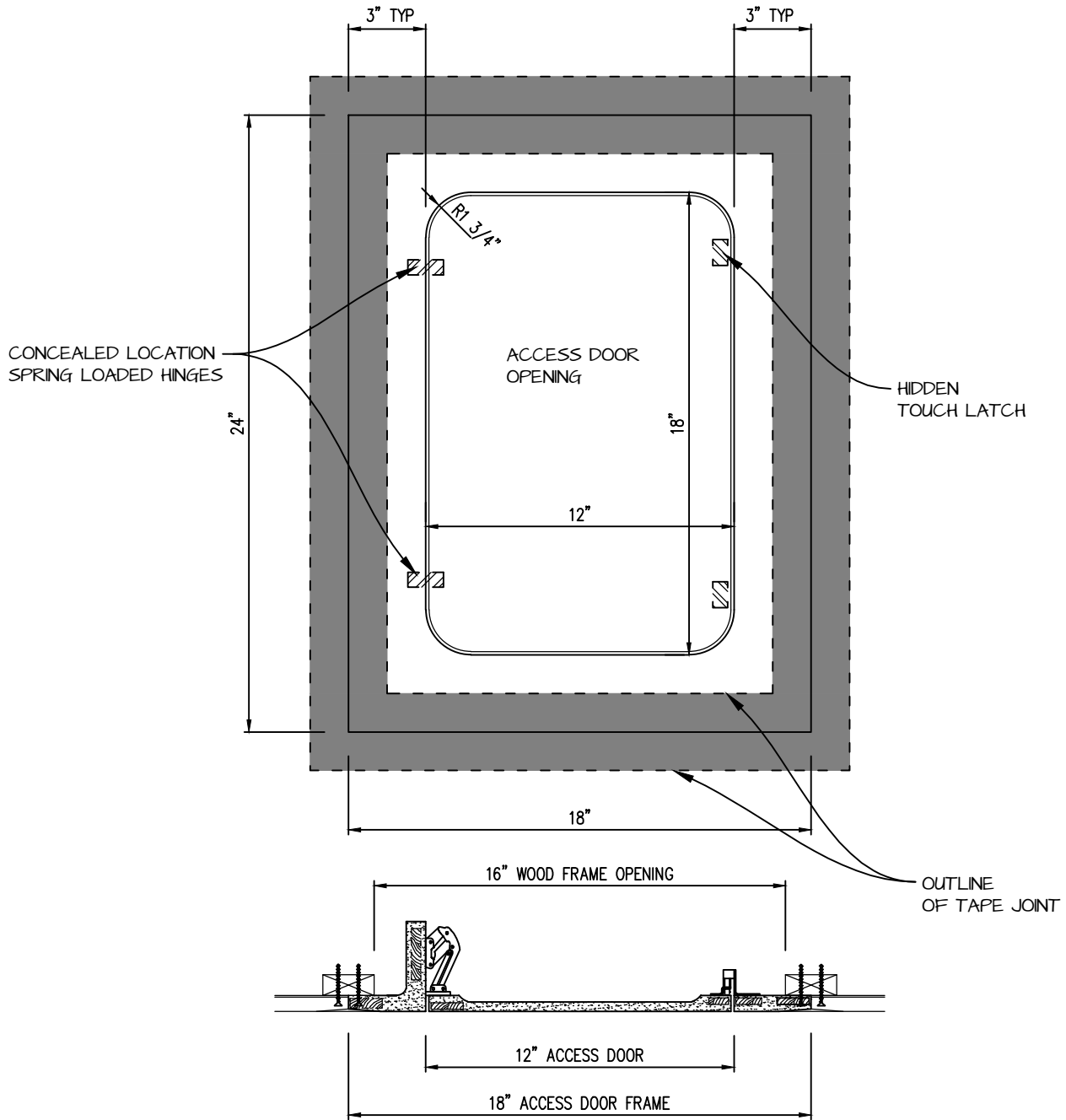

HINGED RADIUS CORNER ACCESS PANEL 12"x18"

GFRG-HG-RC-581218 (TL)



 <p>CASTLE Access Panels & Forms Inc.</p>	<p>CASTLE ACCESS PANELS & FORMS INC. 173 Adesso Drive, Unit 2, Concord ON L4K 3C3 Phone (905)738-8089 Fax (905)760-9234 inquiries@castleaccesspanels.com www.CastleAccessPanels.com</p>	DESIGNED: Q.P
		DATE:
		APPROVED: J.R
CUSTOMER:	PROJECT:	QTY:
TITLE:	DWG NO:	SHEET OF

HINGED GFRG ACCESS PANEL SECTION

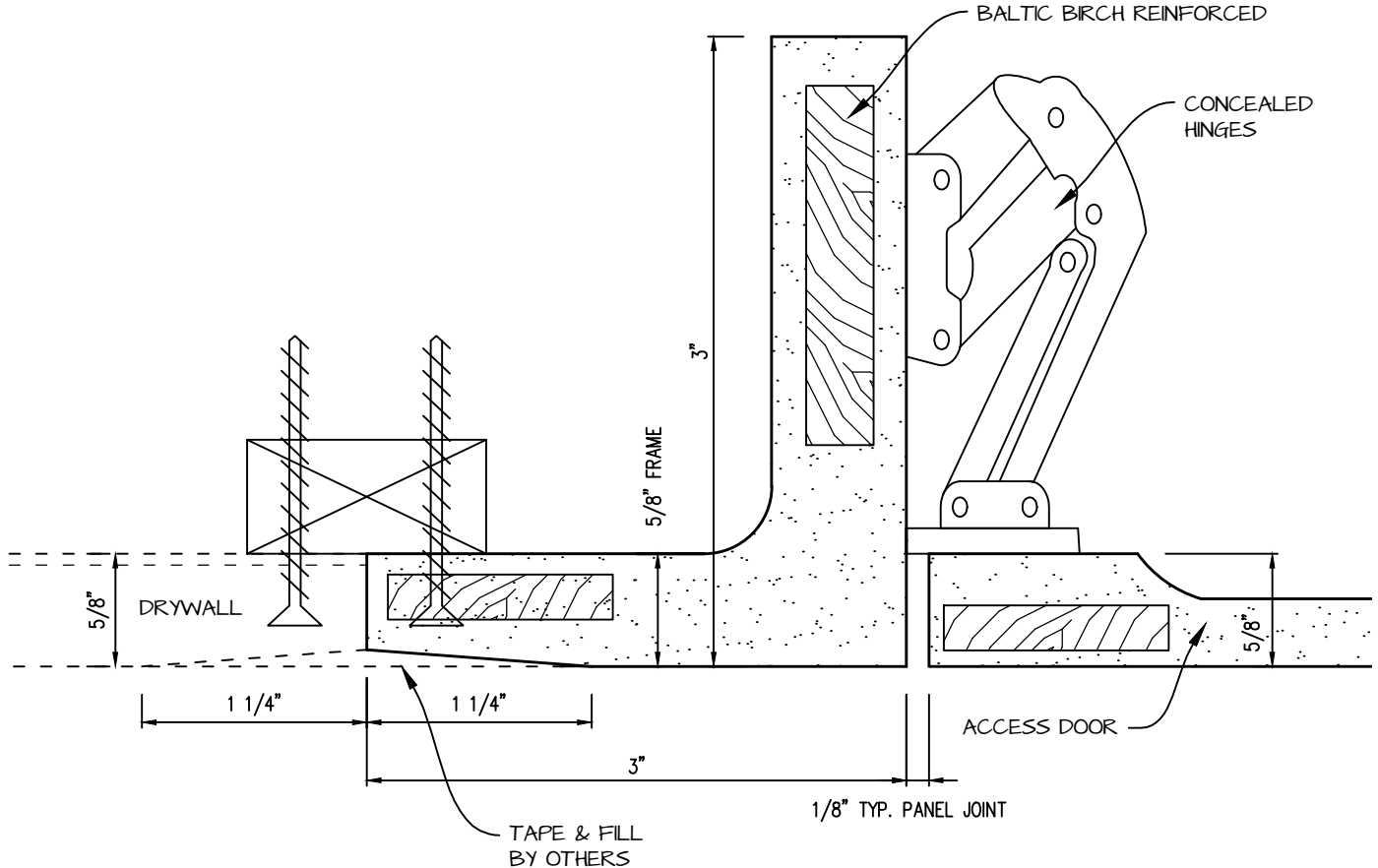
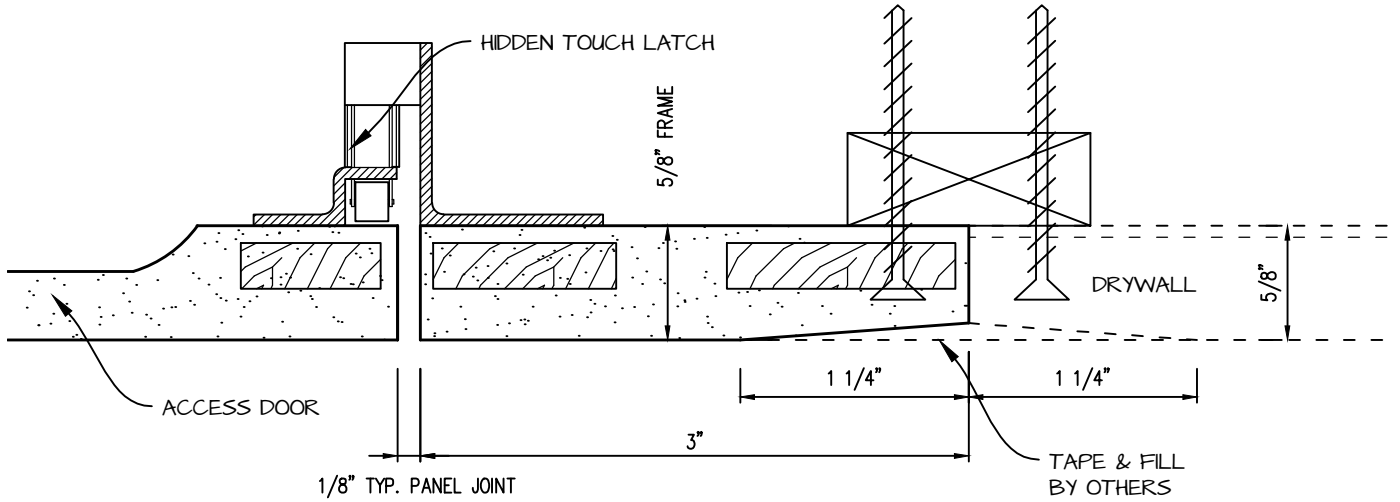

 <p>CASTLE Access Panels & Forms Inc.</p>	<p>CASTLE ACCESS PANELS & FORMS INC. 173 Adesso Drive, Unit 2, Concord ON L4K 3C3 Phone (905)738-8089 Fax (905)760-9234 inquiries@castleaccesspanels.com www.CastleAccessPanels.com</p>	DESIGNED: Q.P
		DATE:
		APPROVED: J.R
CUSTOMER:	PROJECT:	QTY:
TITLE:	DWG NO:	SHEET OF