

# HINGED RADIUS CORNER ACCESS PANEL 24"x44"

## GFRG-HG-RC-582444

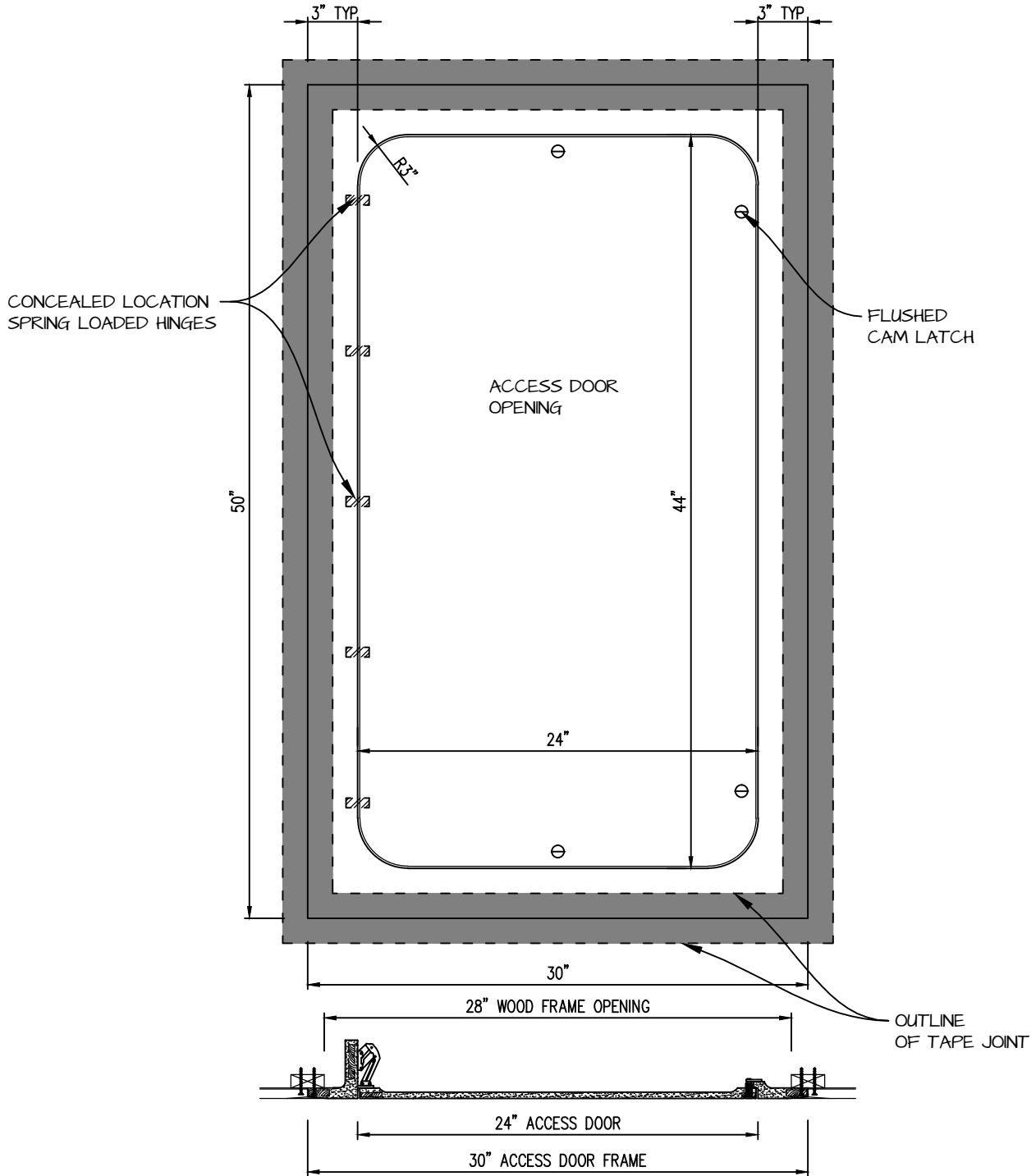

**CASTLE ACCESS PANELS & FORMS INC.**

173 Adesso Drive, Unit 2, Concord ON L4K 3C3

Phone (905)738-8089 Fax (905)760-9234

inquiries@castleaccesspanels.com

[www.CastleAccessPanels.com](http://www.CastleAccessPanels.com)

DESIGNED: Q.P

DATE:

APPROVED: J.R

CUSTOMER:

PROJECT:

QTY:

TITLE:

DWG NO:

SHEET OF

# HINGED GFRG ACCESS PANEL SECTION

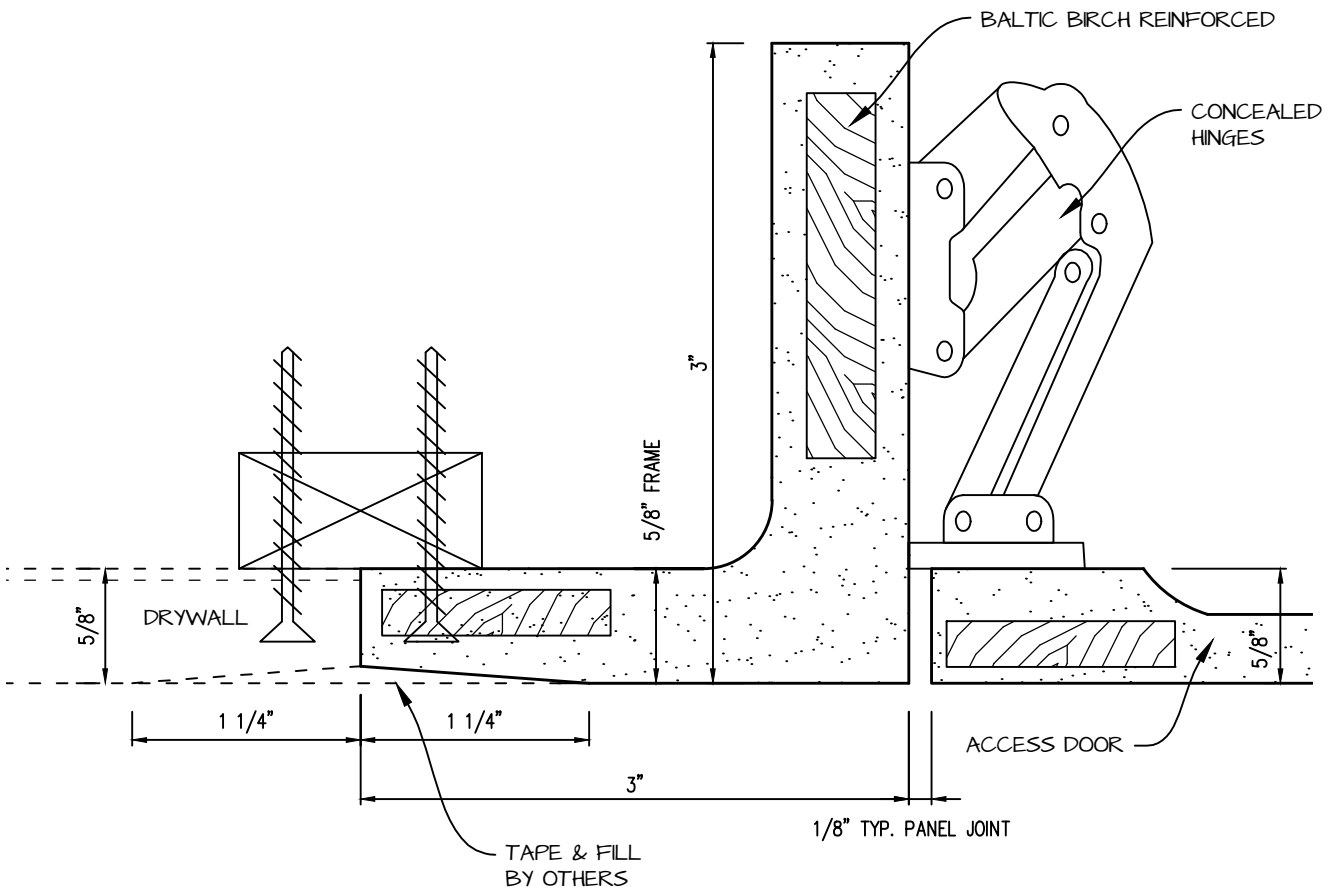

 <p><b>CASTLE</b> Access Panels &amp; Forms Inc.</p>	<p><b>CASTLE ACCESS PANELS &amp; FORMS INC.</b>                  173 Adesso Drive, Unit 2, Concord ON L4K 3C3                  Phone (905)738-8089 Fax (905)760-9234                  inquiries@castleaccesspanels.com  <a href="http://www.CastleAccessPanels.com">www.CastleAccessPanels.com</a></p>		DESIGNED: Q.P. DATE:
			APPROVED: J.R.
CUSTOMER:	PROJECT:	QTY:	
TITLE:	DWG NO:	SHEET OF	