

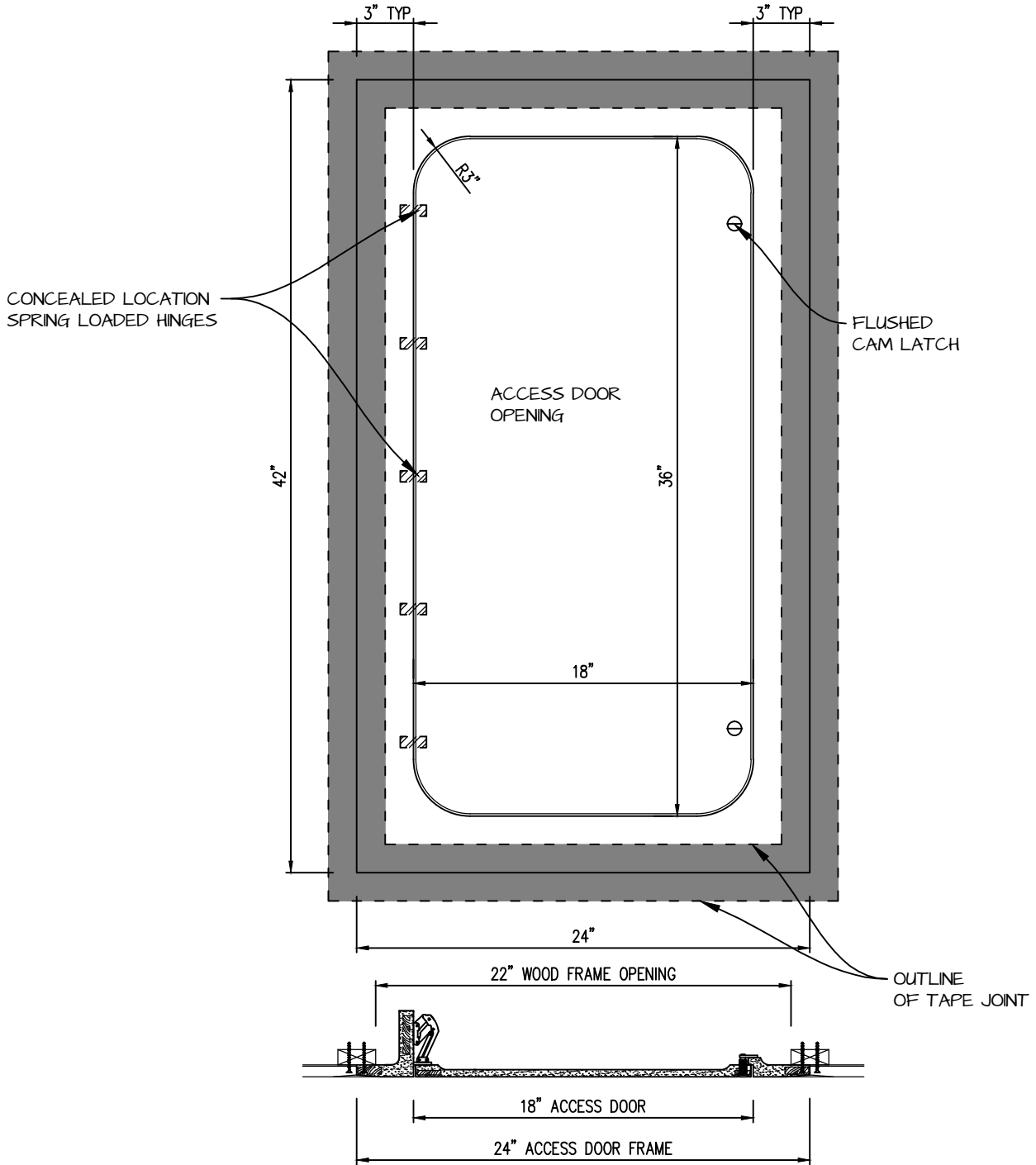

# HINGED RADIUS CORNER ACCESS PANEL 18"x36"

## GFRG-HG-RC-581836



 <p><b>CASTLE</b> Access Panels &amp; Forms Inc.</p>	<p><b>CASTLE ACCESS PANELS &amp; FORMS INC.</b>                  173 Adesso Drive, Unit 2, Concord ON L4K 3C3                  Phone (905)738-8089 Fax (905)760-9234                  inquiries@castleaccesspanels.com  <a href="http://www.CastleAccessPanels.com">www.CastleAccessPanels.com</a></p>	DESIGNED: Q.P
		DATE:
		APPROVED: J.R
CUSTOMER:	PROJECT:	QTY:
TITLE:	DWG NO:	SHEET OF

# HINGED GFRG ACCESS PANEL SECTION

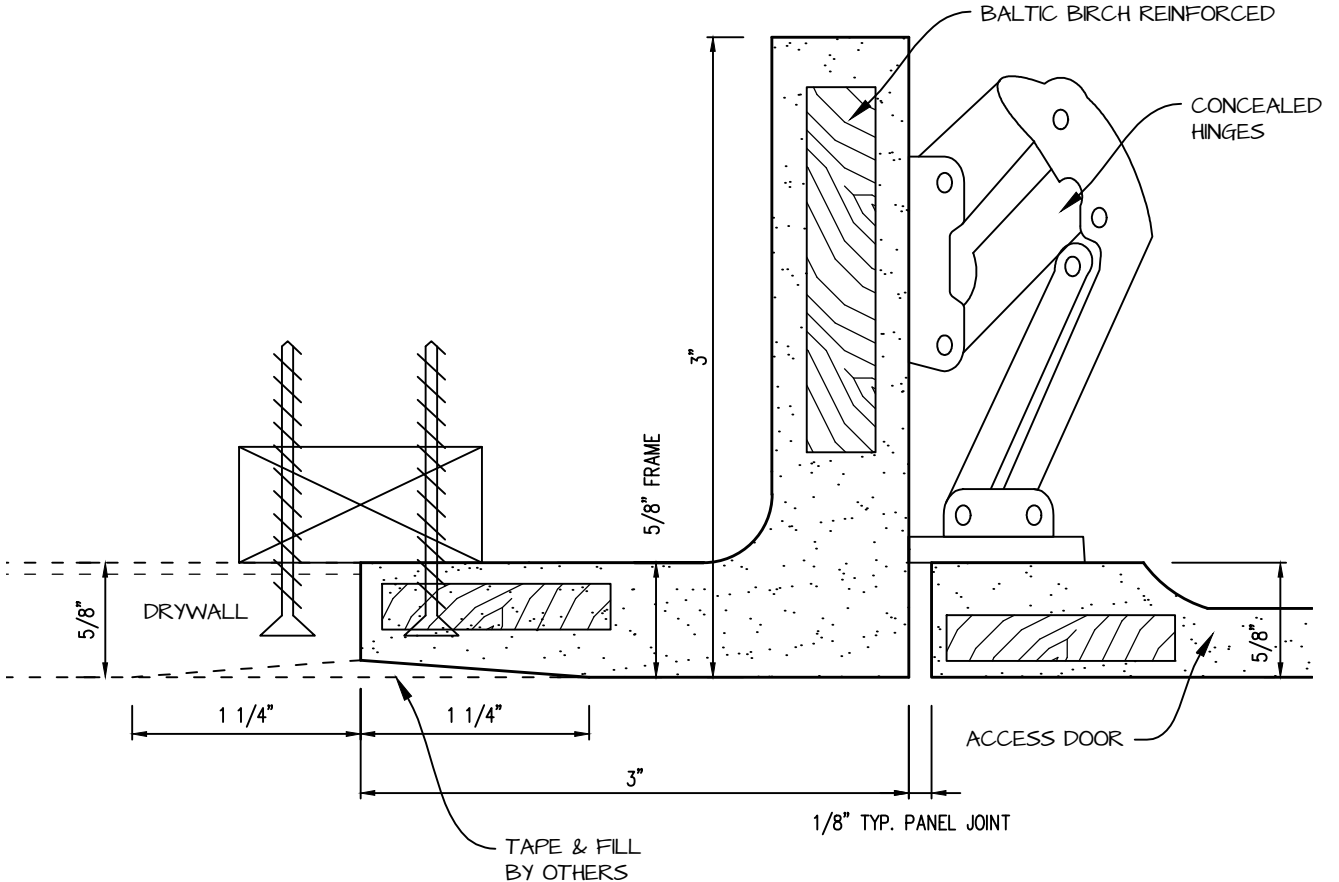

 <p><b>CASTLE</b> Access Panels &amp; Forms Inc.</p>	<p><b>CASTLE ACCESS PANELS &amp; FORMS INC.</b>                  173 Adesso Drive, Unit 2, Concord ON L4K 3C3                  Phone (905)738-8089 Fax (905)760-9234                  inquiries@castleaccesspanels.com  <a href="http://www.CastleAccessPanels.com">www.CastleAccessPanels.com</a></p>	DESIGNED: Q.P. DATE:
	APPROVED: J.R.	
CUSTOMER:	PROJECT:	QTY:
TITLE:	DWG NO:	SHEET OF