

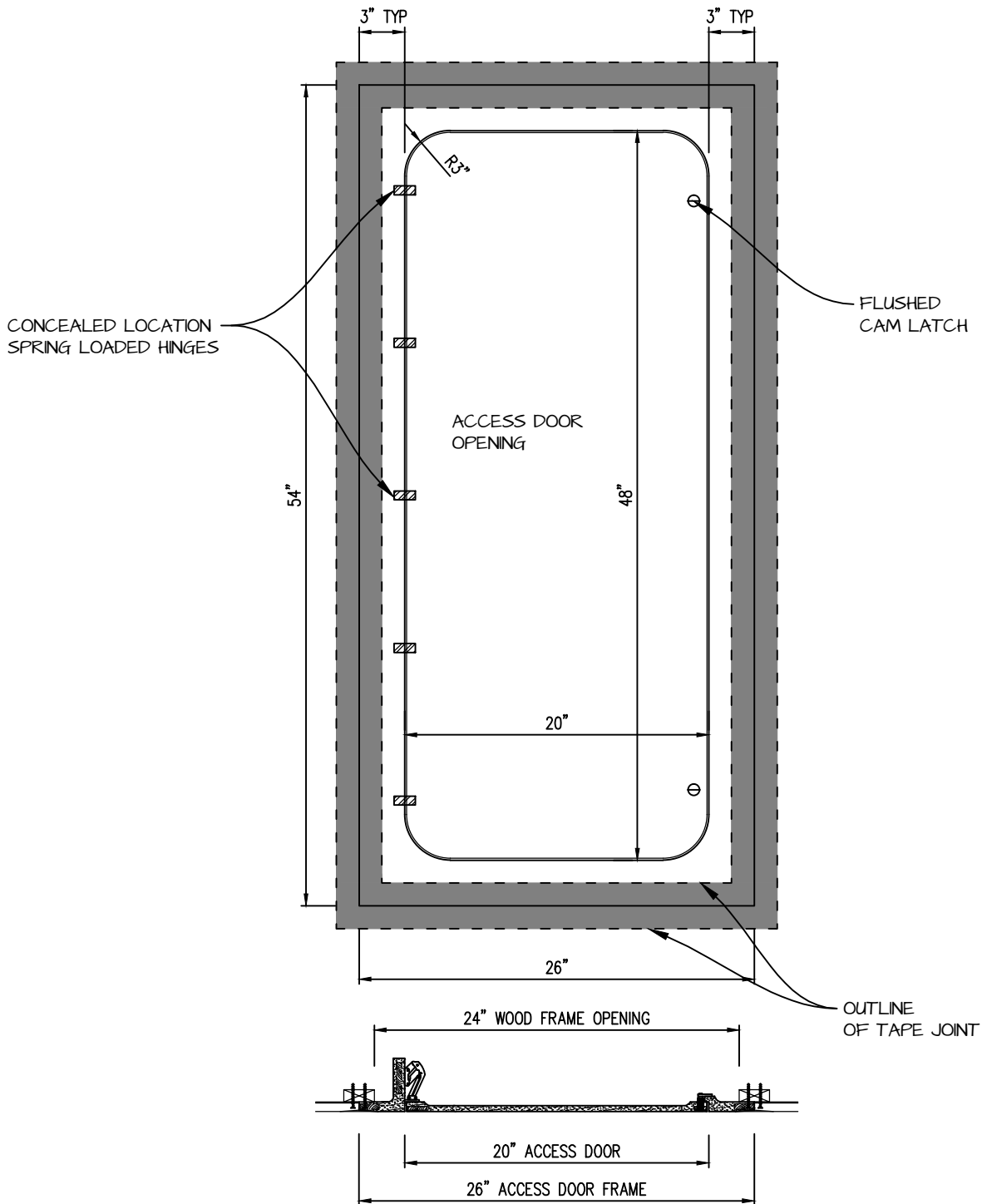

HINGED RADIUS CORNER ACCESS PANEL 20"x48"

GFRG-HG-RC-582048



 CASTLE <small>Access Panels & Forms Inc.</small>	CASTLE ACCESS PANELS & FORMS INC. 173 Adesso Drive, Unit 2, Concord ON L4K 3C3 Phone (905)738-8089 Fax (905)760-9234 inquiries@castleaccesspanels.com www.CastleAccessPanels.com	DESIGNED:	Q.P
		DATE:	
		APPROVED:	J.R
CUSTOMER:	PROJECT:	QTY:	
TITLE:	DWG NO:	SHEET OF	

HINGED GFRG ACCESS PANEL SECTION

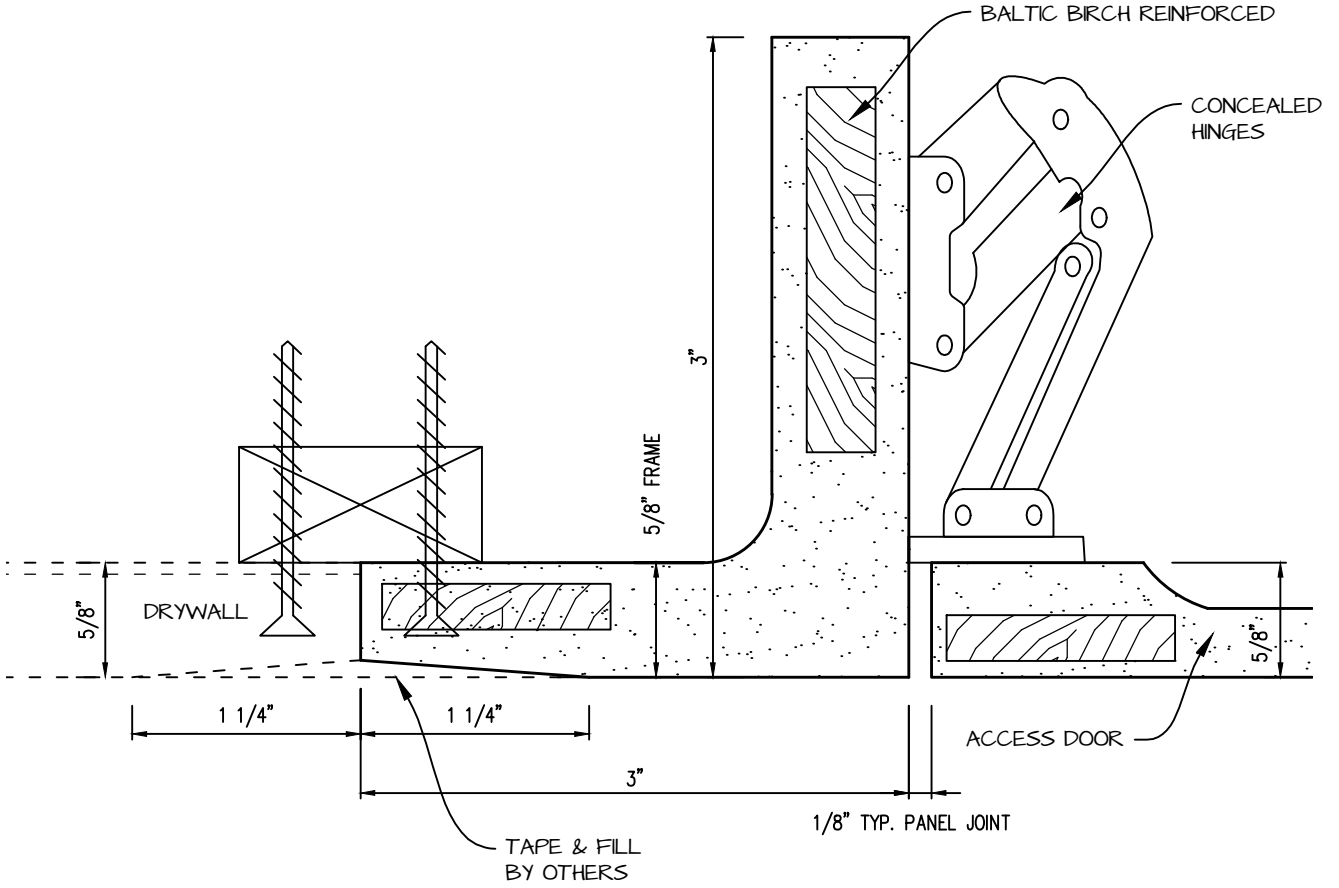

 <p>CASTLE Access Panels & Forms Inc.</p>	<p>CASTLE ACCESS PANELS & FORMS INC. 173 Adesso Drive, Unit 2, Concord ON L4K 3C3 Phone (905)738-8089 Fax (905)760-9234 inquiries@castleaccesspanels.com www.CastleAccessPanels.com</p>	DESIGNED: Q.P. DATE:
	APPROVED: J.R.	
CUSTOMER:	PROJECT:	QTY:
TITLE:	DWG NO:	SHEET OF