

HINGED SQUARE CORNER ACCESS PANEL 6"x18"

GFRG-HG-SQ-580618 (TL)

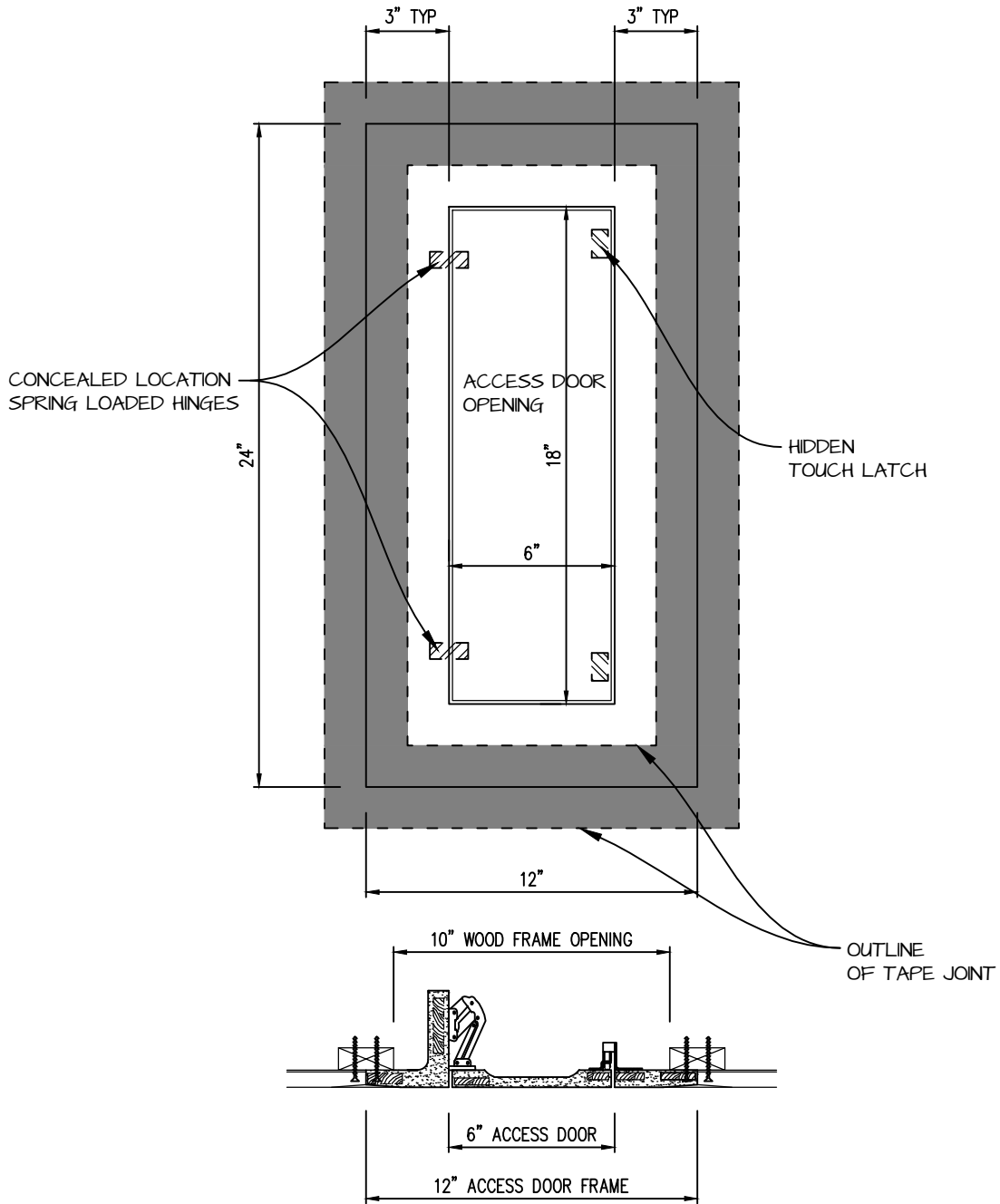

CASTLE ACCESS PANELS & FORMS INC.

173 Adesso Drive, Unit 2, Concord ON L4K 3C3

Phone (905)738-8089 Fax (905)760-9234

inquiries@castleaccesspanels.com

www.CastleAccessPanels.com

DESIGNED: Q.P

DATE:

APPROVED: J.R

CUSTOMER:

PROJECT:

QTY:

TITLE:

DWG NO:

SHEET OF

HINGED GFRG ACCESS PANEL SECTION

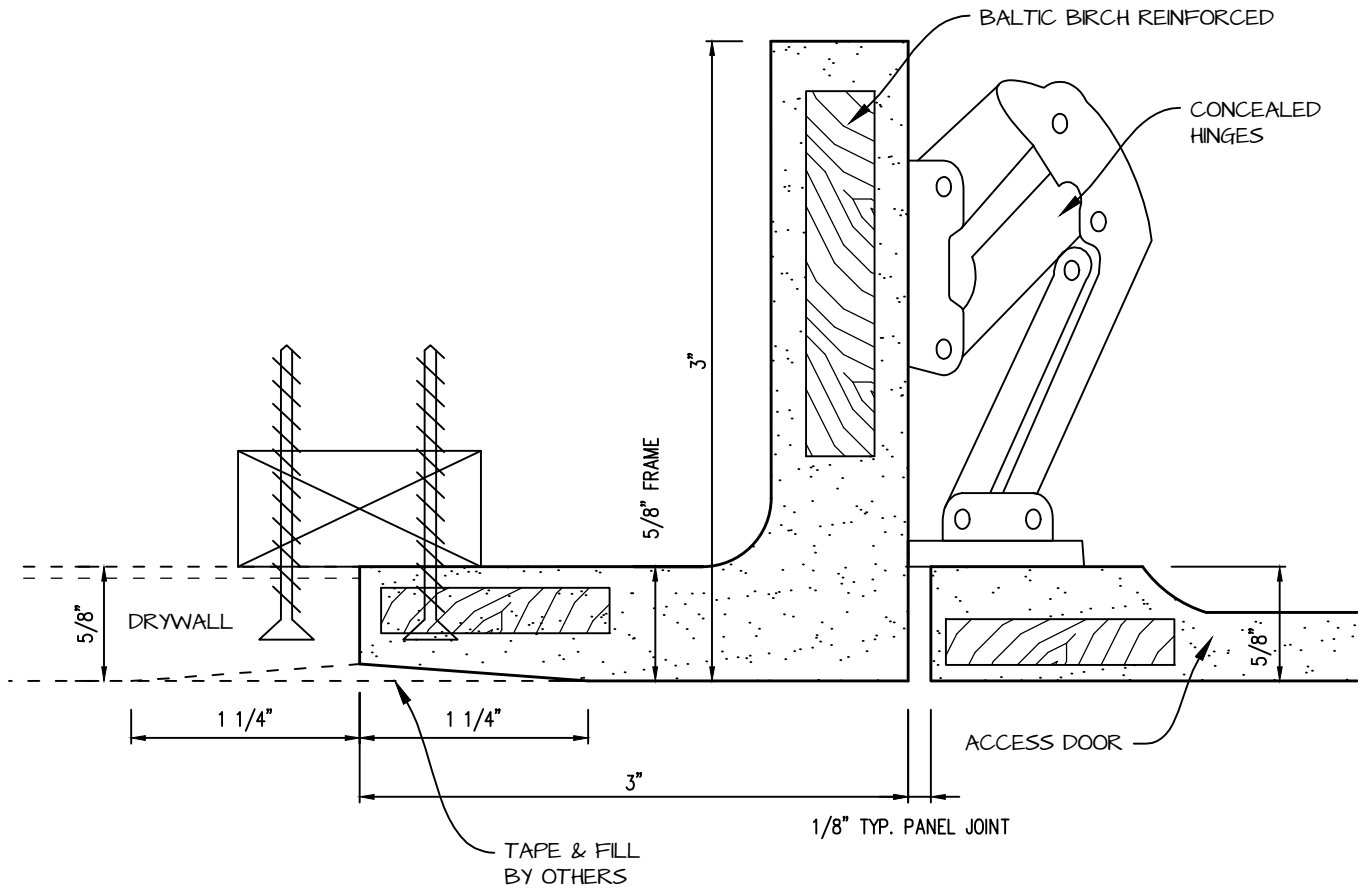
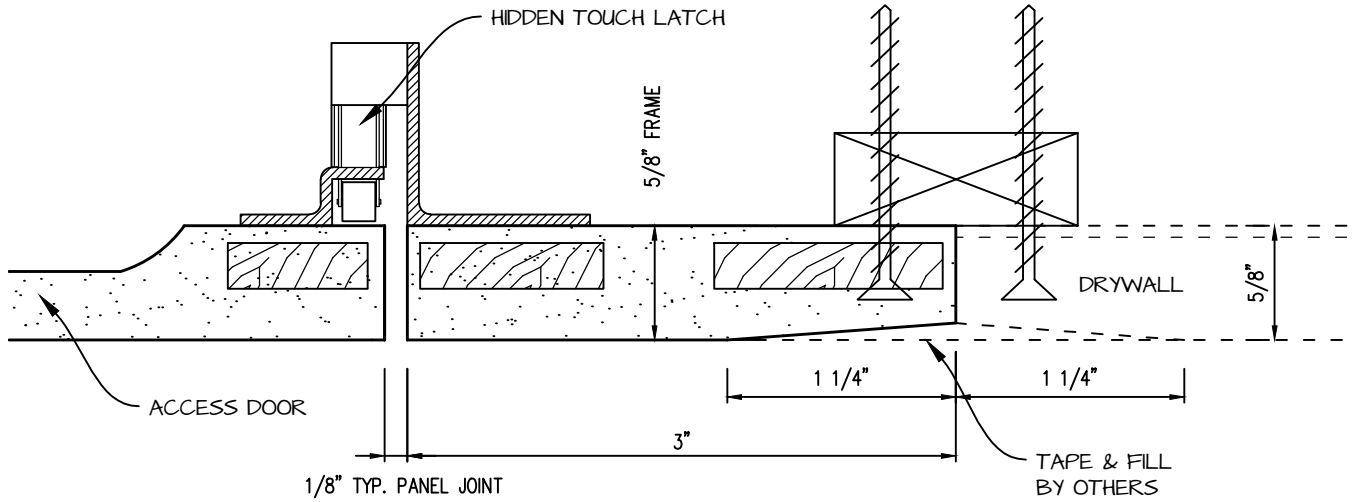

 <p>CASTLE Access Panels & Forms Inc.</p>	<p>CASTLE ACCESS PANELS & FORMS INC. 173 Adesso Drive, Unit 2, Concord ON L4K 3C3 Phone (905)738-8089 Fax (905)760-9234 inquiries@castleaccesspanels.com www.CastleAccessPanels.com</p>	DESIGNED:	Q.P
		DATE:	
		APPROVED:	J.R
CUSTOMER:	PROJECT:	QTY:	
TITLE:	DWG NO:	SHEET OF	