

# HINGED SQUARE CORNER ACCESS PANEL 12"x24"

## GFRG-HG-SQ-581224

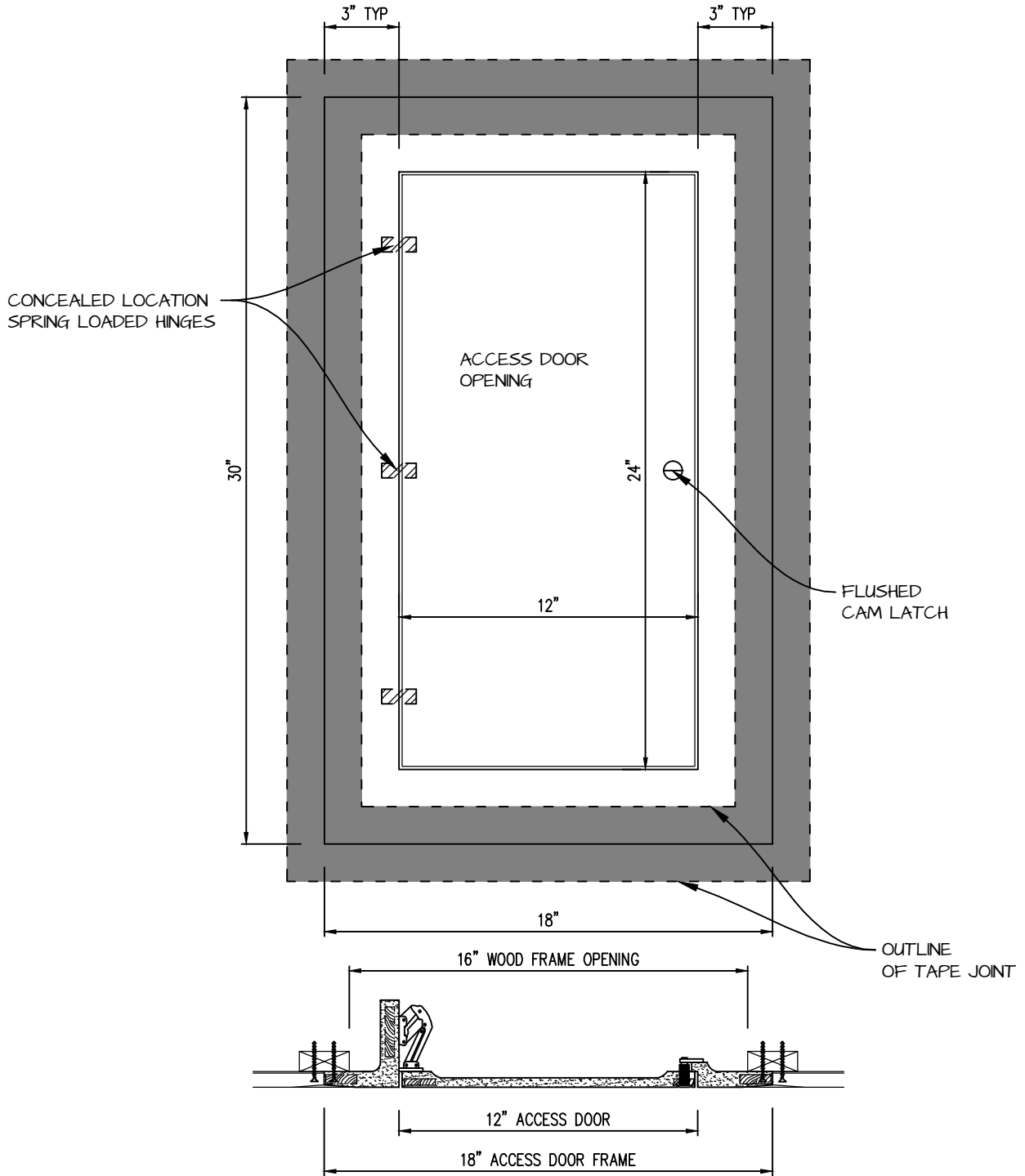



**CASTLE ACCESS PANELS & FORMS INC.**  
 173 Adesso Drive, Unit 2, Concord ON L4K 3C3  
 Phone (905)738-8089 Fax (905)760-9234  
 inquiries@castleaccesspanels.com  
[www.CastleAccessPanels.com](http://www.CastleAccessPanels.com)

DESIGNED:	Q.P
DATE:	
APPROVED:	J.R

CUSTOMER:	PROJECT:	QTY:
TITLE:	DWG NO:	SHEET OF

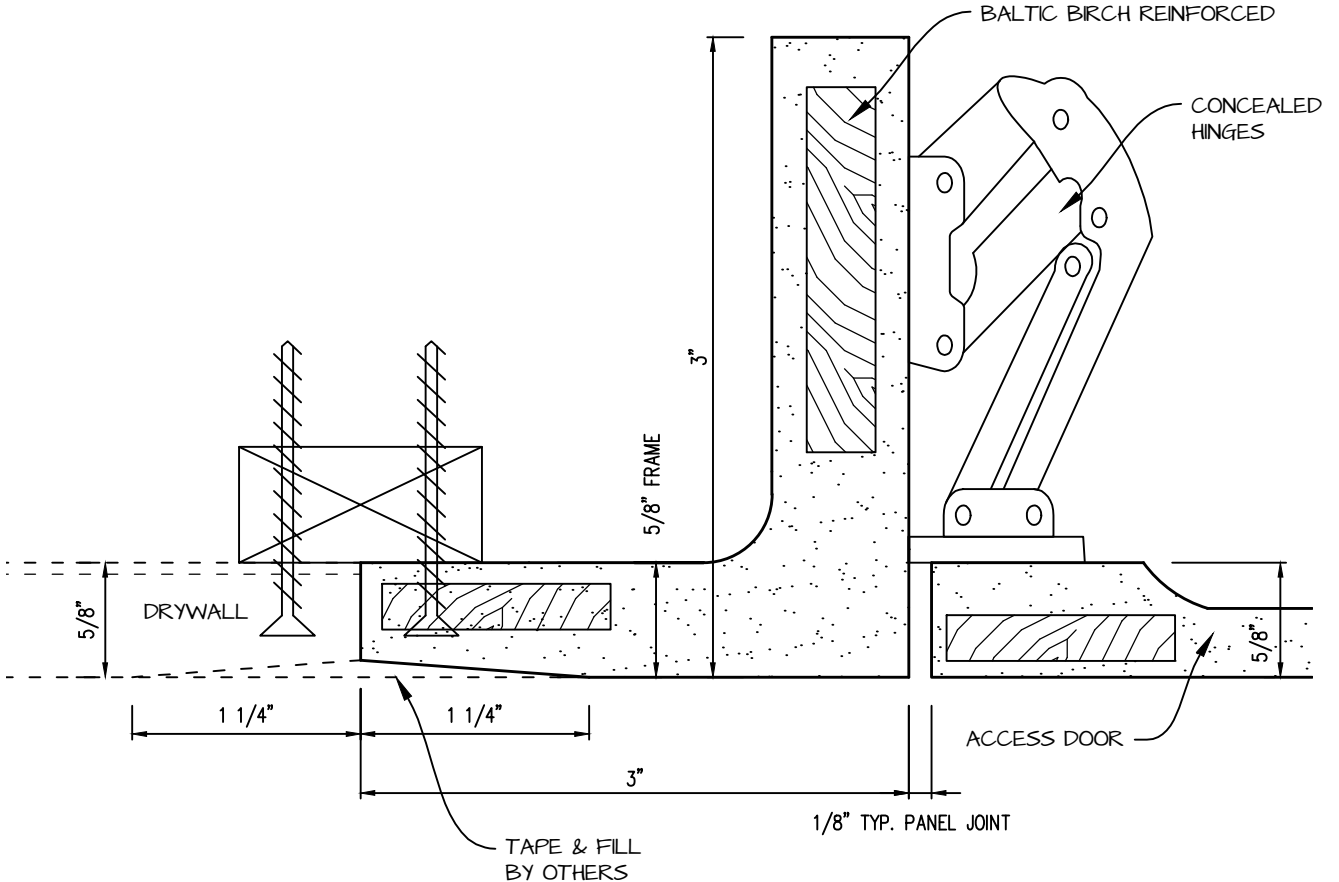
# HINGED GFRG ACCESS PANEL SECTION



 <p><b>CASTLE</b> Access Panels &amp; Forms Inc.</p>	<p><b>CASTLE ACCESS PANELS &amp; FORMS INC.</b>                  173 Adesso Drive, Unit 2, Concord ON L4K 3C3                  Phone (905)738-8089 Fax (905)760-9234                  inquiries@castleaccesspanels.com                  www.CastleAccessPanels.com</p>		DESIGNED: Q.P. DATE:
			APPROVED: J.R.
CUSTOMER:	PROJECT:	QTY:	
TITLE:	DWG NO:	SHEET OF	