

HINGED SQUARE CORNER ACCESS PANEL 38"x46"

GFRG-HG-SQ-583846

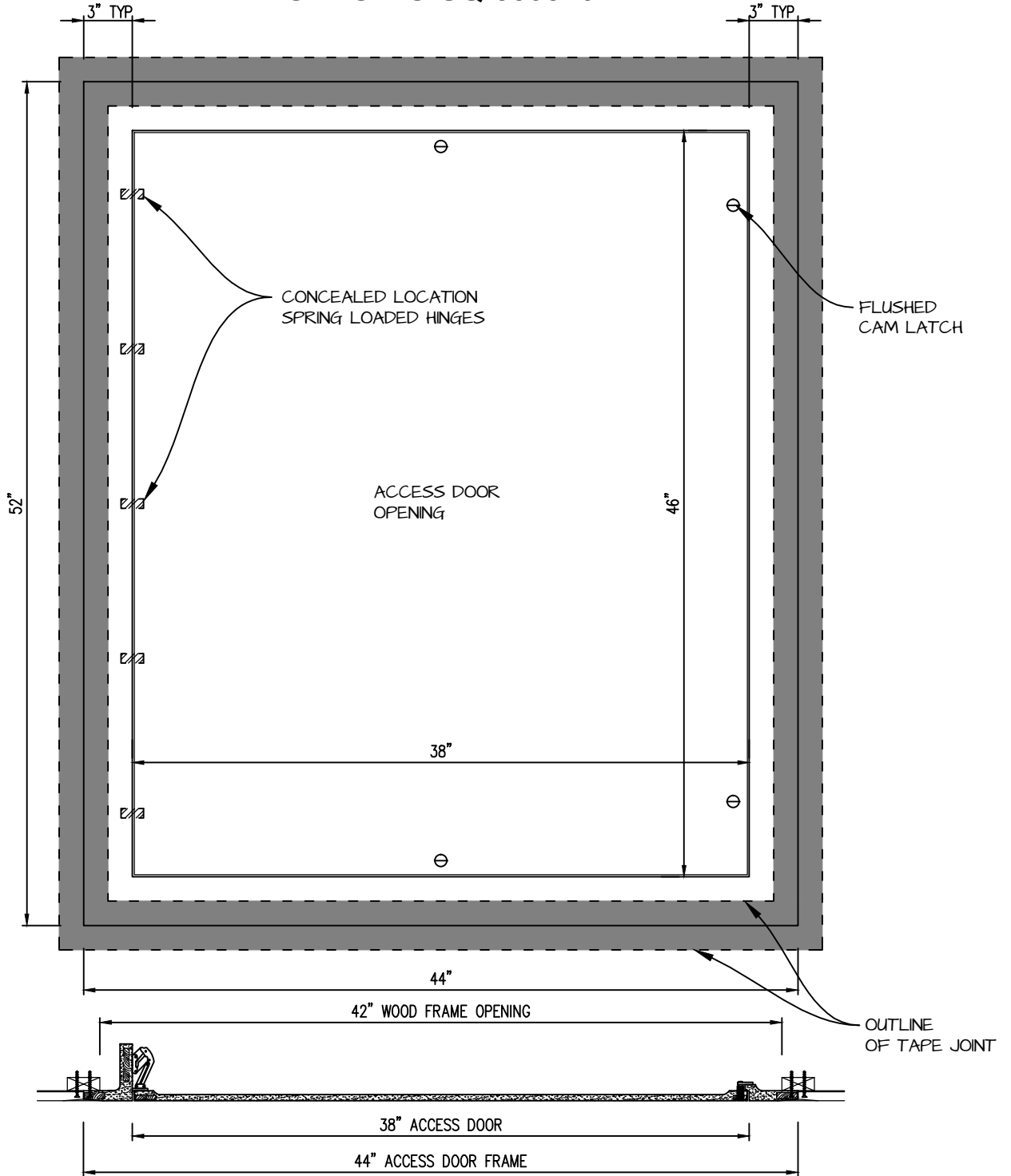

CASTLE ACCESS PANELS & FORMS INC.
 173 Adesso Drive, Unit 2, Concord ON L4K 3C3
 Phone (905)738-8089 Fax (905)760-9234
 inquiries@castleaccesspanels.com
www.CastleAccessPanels.com

DESIGNED: Q.P
 DATE:

APPROVED: J.R

CUSTOMER:

PROJECT:

QTY:

TITLE:

DWG NO:

SHEET OF

HINGED GFRG ACCESS PANEL SECTION

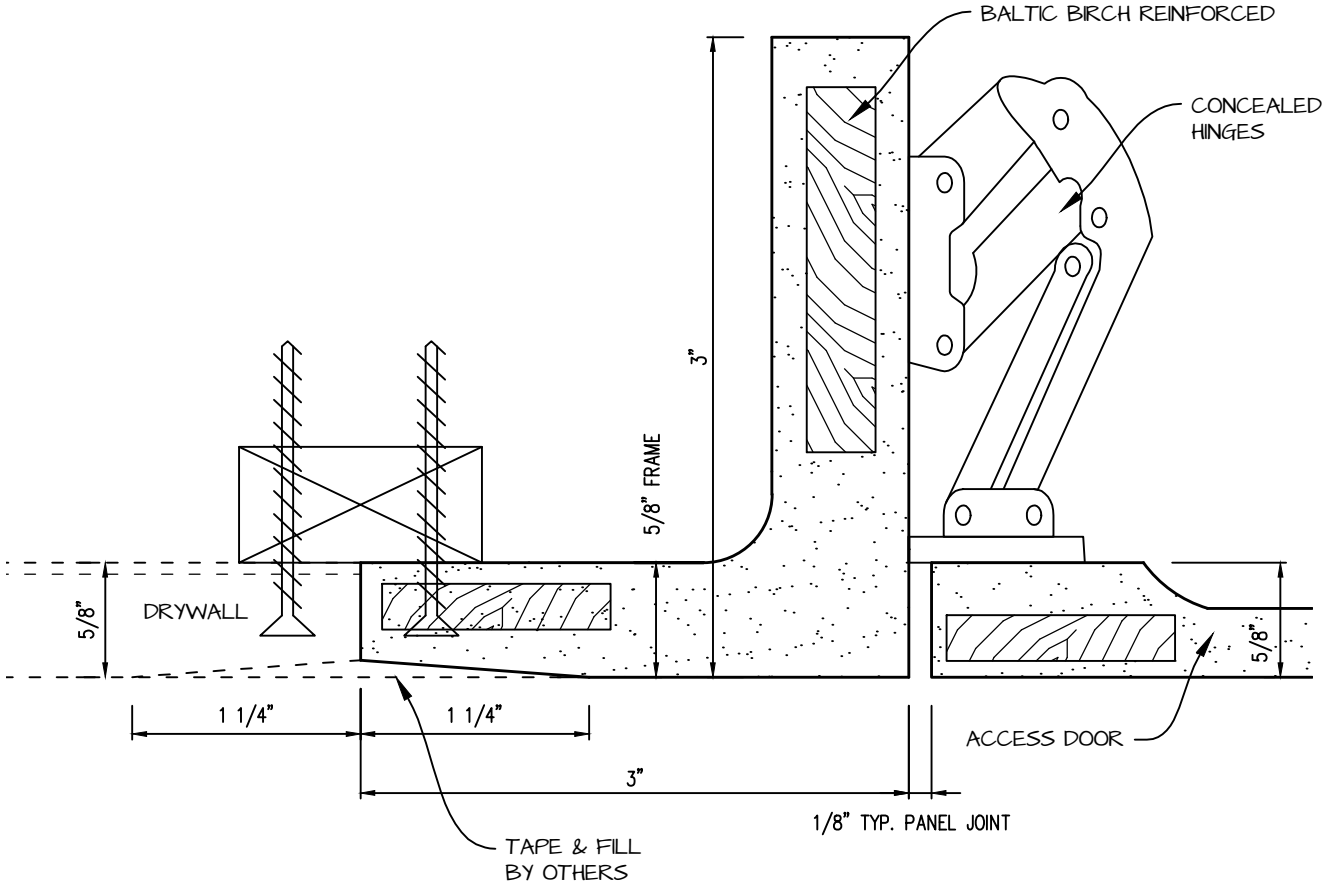
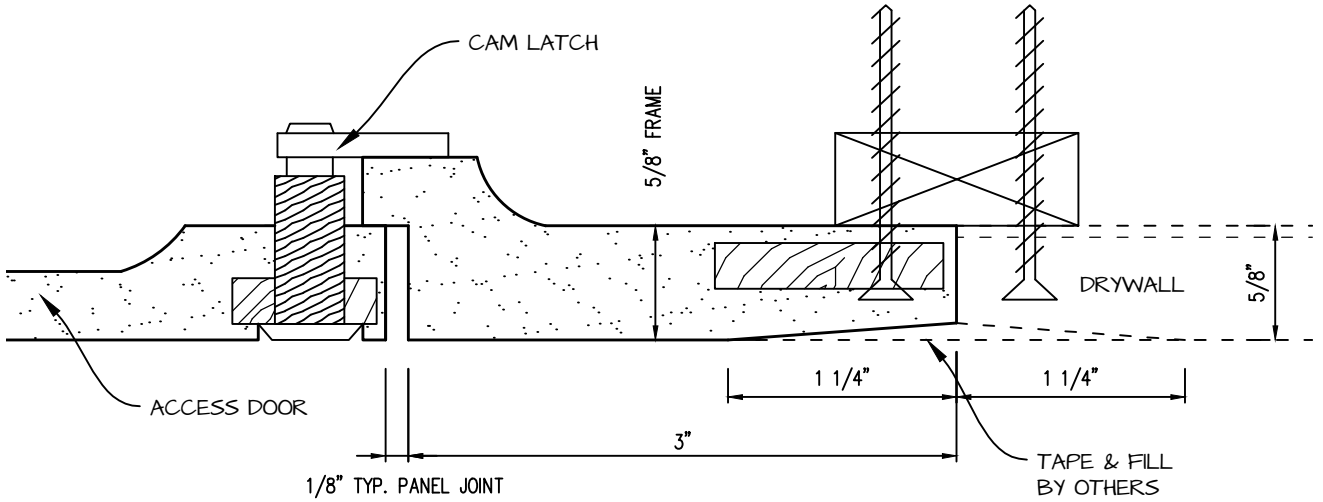

 <p>CASTLE Access Panels & Forms Inc.</p>	<p>CASTLE ACCESS PANELS & FORMS INC. 173 Adesso Drive, Unit 2, Concord ON L4K 3C3 Phone (905)738-8089 Fax (905)760-9234 inquiries@castleaccesspanels.com www.CastleAccessPanels.com</p>	DESIGNED: Q.P. DATE:
		APPROVED: J.R.
CUSTOMER:	PROJECT:	QTY:
TITLE:	DWG NO:	SHEET OF