

**POP OUT RADIUS CORNER ACCESS PANEL 30"x34"**  
**GFRG-RC-583034**

TOP VIEW

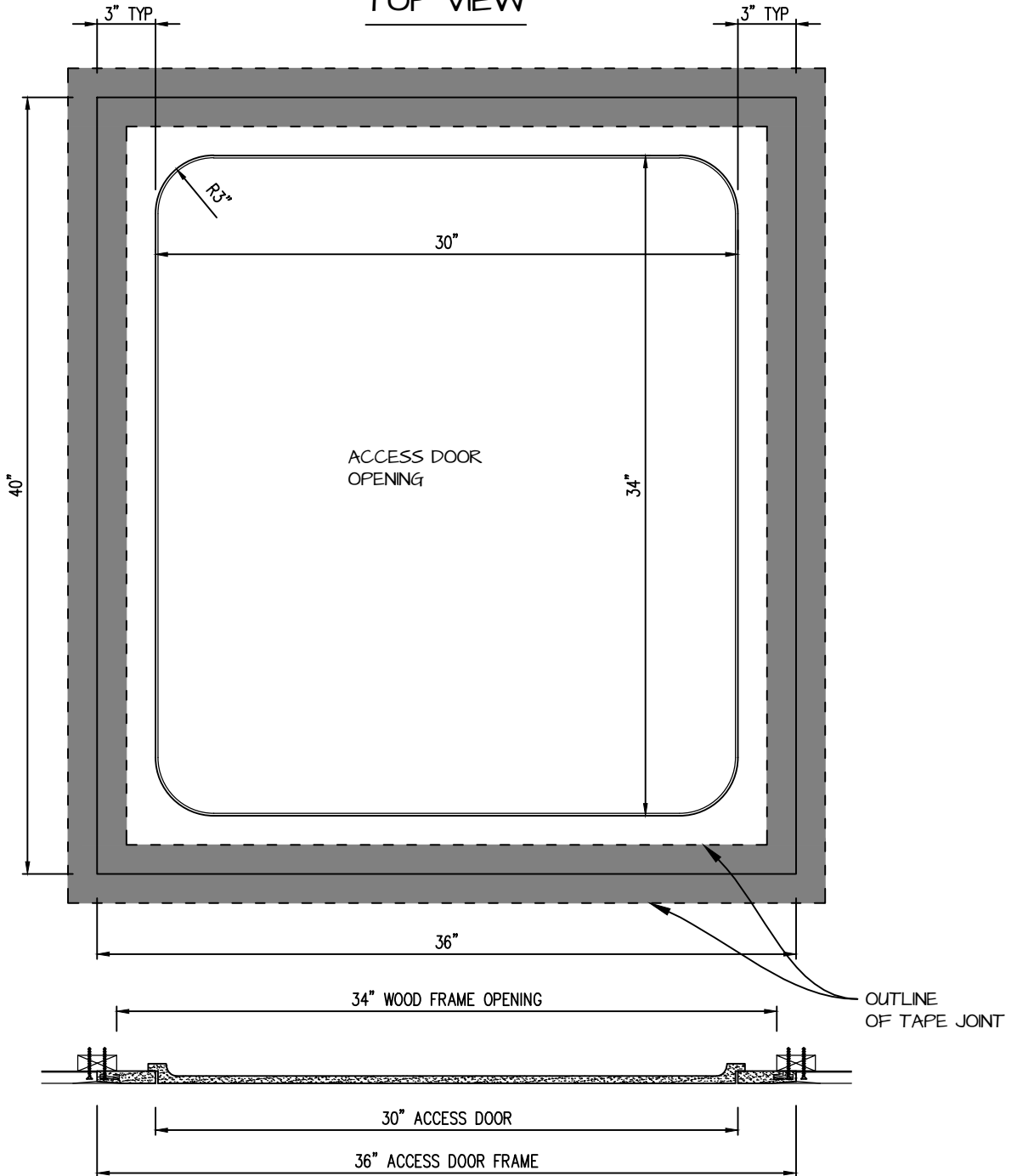

**CASTLE ACCESS PANELS & FORMS INC.**  
 173 Adesso Drive, Unit 2, Concord ON L4K 3C3  
 Phone (905)738-8089 Fax (905)760-9234  
 inquiries@castleaccesspanels.com  
[www.CastleAccessPanels.com](http://www.CastleAccessPanels.com)

DESIGNED: Q.P  
 DATE:

APPROVED: J.R

CUSTOMER:

PROJECT:

QTY:

TITLE:

DWG NO:

SHEET OF

# POP-OUT GFRG ACCESS PANEL SECTION

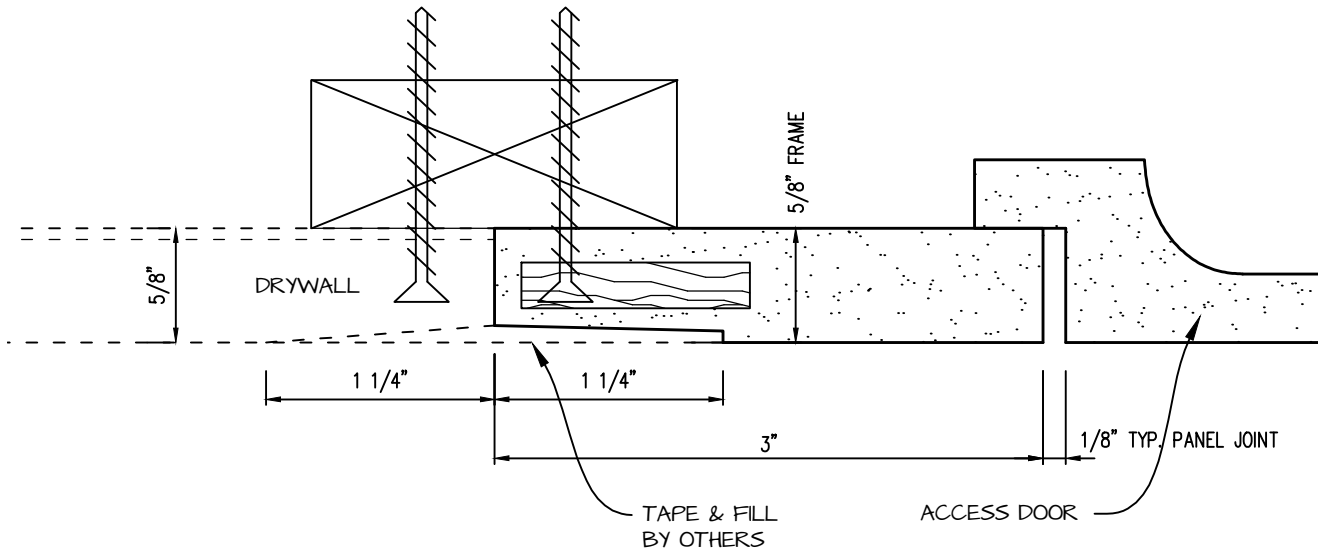
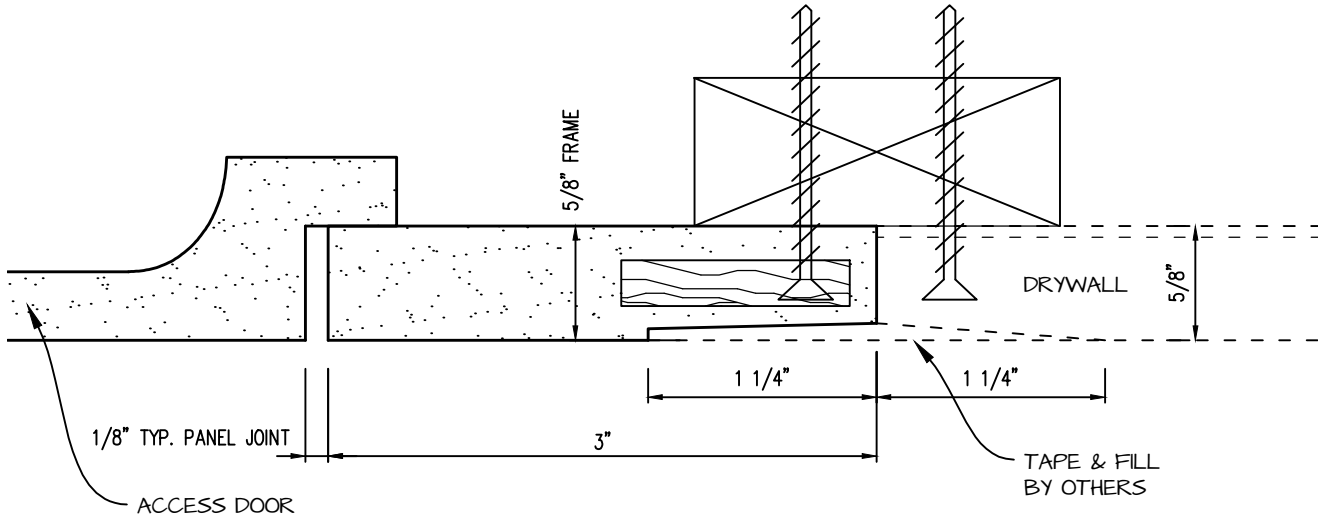

 <p><b>CASTLE ACCESS PANELS &amp; FORMS INC.</b>          173 Adesso Drive, Unit 2, Concord ON L4K 3C3          Phone (905)738-8089 Fax (905)760-9234          inquiries@castleaccesspanels.com  <a href="http://www.CastleAccessPanels.com">www.CastleAccessPanels.com</a></p>	DESIGNED: Q.P	
	DATE:	
	APPROVED: J.R	
CUSTOMER:	PROJECT:	QTY:
TITLE:	DWG NO:	SHEET OF