

POP OUT ROUND ACCESS PANEL 30" DIAMETER
GFRG-RD-580030

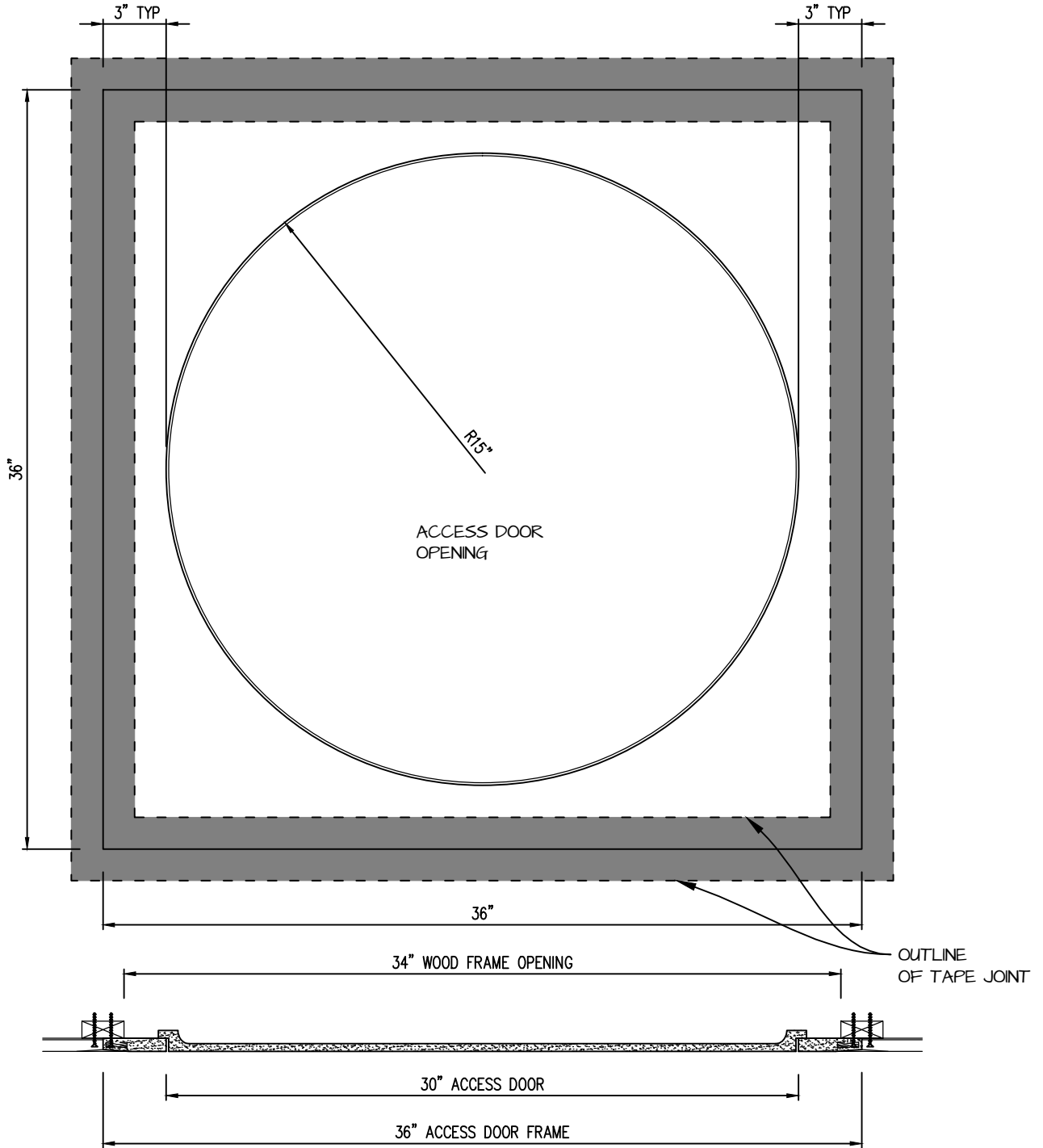

CASTLE ACCESS PANELS & FORMS INC.
 173 Adesso Drive, Unit 2, Concord ON L4K 3C3
 Phone (905)738-8089 Fax (905)760-9234
 inquiries@castleaccesspanels.com
www.CastleAccessPanels.com

DESIGNED: Q.P
 DATE:

APPROVED: J.R

CUSTOMER:

PROJECT:

QTY:

TITLE:

DWG NO:

SHEET OF

POP-OUT GFRG ACCESS PANEL SECTION

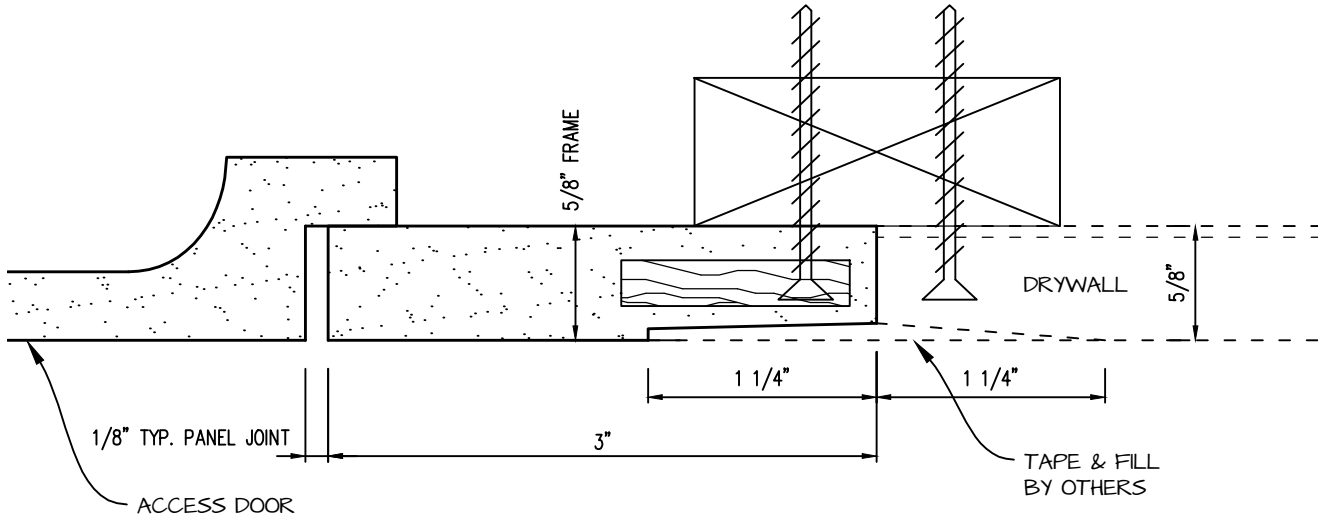

 <p>CASTLE ACCESS PANELS & FORMS INC. 173 Adesso Drive, Unit 2, Concord ON L4K 3C3 Phone (905)738-8089 Fax (905)760-9234 inquiries@castleaccesspanels.com www.CastleAccessPanels.com</p>	DESIGNED: Q.P	
	DATE:	
	APPROVED: J.R	
CUSTOMER:	PROJECT:	QTY:
TITLE:	DWG NO:	SHEET OF